











# SMARTair™ Cylinders

## Wireless and battery powered

### Technical data – SMARTair™ cylinders

	<b>Application</b>	Ideal for office or meeting room doors
	<b>Door profiles</b>	Euro, Scandinavian, suitable for wooden, narrow or glass doors
	<b>Verticals</b>	All industries
	<b>Traffic volume</b>	Medium
	<b>Exterior usage</b>	Yes (IP55), Up to 85% humidity without condensation, Temperature (0°C and +70°C)
	<b>Hardware compatibility and installation</b>	Very high retrofit, No drilling, no cabling
	<b>Power supply</b>	Battery (up to 40.000 Cycles, max. 2 years standby)
	<b>System management</b>	Stand-Alone, Offline, Update on Card, Wireless online
	<b>Multi-authentication</b>	No
	<b>Status information</b>	No
	<b>Certifications</b>	CE

### SMARTair™ cylinders – versions and profiles

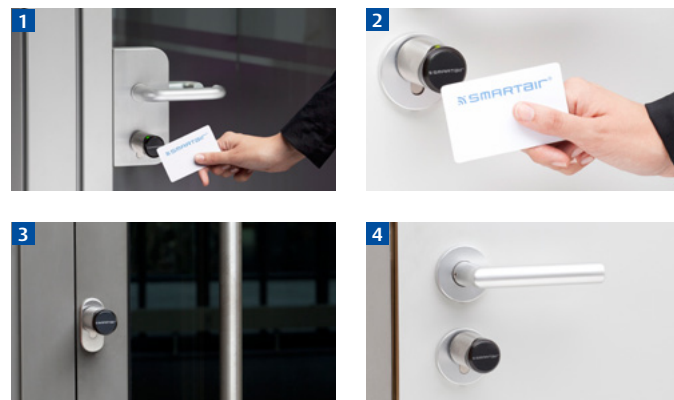

1. Suitable for glass door applications
2. RFID reader with LED (green/red signal) with 2-4cm read/write distance
3. Suitable for usage at exterior and narrow profile doors
4. Panic function: Internal knob turning always opens door (only Euro profile)

### Technical drawings and dimensions

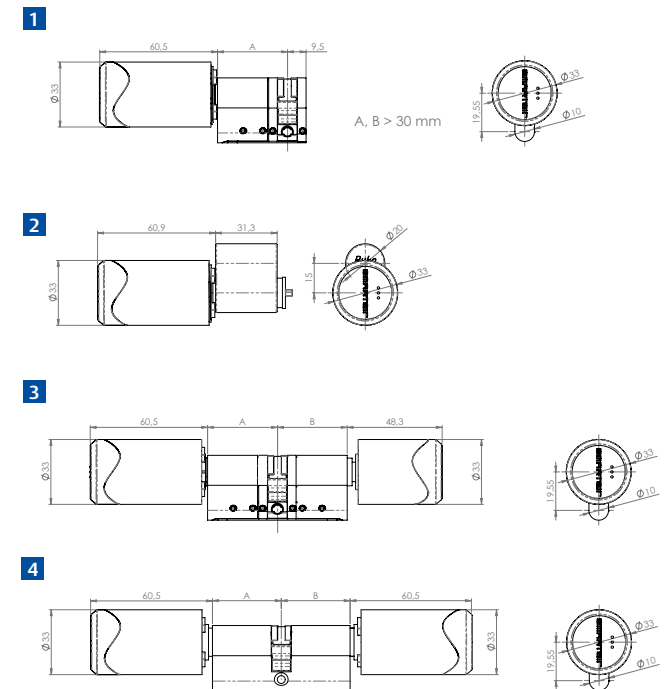

1. Single knob cylinder European profile
2. Single knob cylinder Scandinavian profile
3. Double knob cylinder European profile
4. Double knob cylinder European profile with double side electronic